

2A Series

Sealed Sub-Miniature Toggle Switches



2A
Toggle Switches



IP 67
ACCORDING TO
EN 60529:1989
IEC 60529:2011



RoHS
compliant



SPECIFICATIONS

CONTACT RATING: Dependent upon contact material See Page 34.

MECHANICAL LIFE: 30,000 make-and-break cycles.

CONTACT RESISTANCE: 20 mΩ max. initial @ 2-4VDC
100mA for both silver and gold plated contacts.

INSULATION RESISTANCE: 1,000 MΩ min.

DIELECTRIC STRENGTH: 1,000 Vrms min.@sea level.

OPERATING TEMPERATURE: -40°C to 85°C.

MATERIALS

CASE & BUSHING: Glass filled nylon 6/6, flame retardant,
heat stabilized (UL94v-0).

ACTUATOR: Brass, chrome plated, internal O-ring seal.
Standard for all actuators.

SWITCH SUPPORT: Brass, tin plated.

CONTACT / TERMINALS: Copper alloy with Silver or gold plated.
(See Page 34)

HOW TO ORDER

MODEL NO.	ACTUATOR	BUSHING	TERMINATIONS	TERMINAL PLATING	SEAL	RoHS SOLDERING
<ul style="list-style-type: none"> Model NO. 2AS1 SP On-None-On 2AS2 SP On-None-Mom. 2AS3 SP On-Off -On 2AS4 SP Mom.-Off-Mom. 2AS5 SP On-Off-Mom. 2AS6 SP Off-None-On 2AD1 DP On-None-On 2AD2 DP On-None-Mom. 2AD3 DP On-Off-On 	<ul style="list-style-type: none"> Actuator T1 10.16 high T2 6.10 high T3 8.13 high T4 13.97 high TA Plastic,Black 10.16 high TB Plastic,Black 6.10 high 	<ul style="list-style-type: none"> Bushing A1 SP 4.65 high A2 DP 4.50 high A3 SP 5.00 high 	<ul style="list-style-type: none"> Terminations M2 PC thru-hole M5 Wire wrap M6 Right angle, PC thru-hole M6N Right angle, snap-in, PC thru-hole M7 Vertical right angle, PC thru-hole M7N Vertical right angle, snap-in, PC thru-hole VS2 9.30 high V-bracket V2N 9.30 high Snap-in V-bracket 	<ul style="list-style-type: none"> Terminal plating Q Gold flash over silver R Gold C Gold over silver 	<ul style="list-style-type: none"> Seal E EPOXY (std) 	<ul style="list-style-type: none"> RoHS soldering S RoHS & Lead Free
<p>* 2AS6 model type not applicable to M6/M6N/M7/M7N terminations</p>						

2A Series

Sealed Sub-Miniature Toggle Switches

SWITCH FUNCTION

NO. POLES	UL/CSA MODEL NO.	MODEL NO.	SWITCH FUNCTION			CONNECTED TERMINALS / SCHEMATIC		
			POS.1	POS.2	POS.3	POS.1	POS.2	POS.3
SP	Q22A11	2AS1	ON	NONE	ON	2-3	N/A	2-1
	Q22A12	2AS2	ON	NONE	MOM			
	Q22A13	2AS3	ON	OFF	ON			
	Q22A14	2AS4	MOM	OFF	MOM			
	Q22A15	2AS5	ON	OFF	MOM			
	DP	Q22A16	2AS6	OFF	NONE	ON	OPEN	N/A
Q22A21		2AD1	ON	NONE	ON	2-3,5-6	N/A	2-1,5-4
Q22A22		2AD2	ON	NONE	MOM			
Q22A23	2AD3	ON	OFF	ON		OPEN		

MOM=MOMENTARY



2A
Toggle Switches

POLE OPTIONS

M2

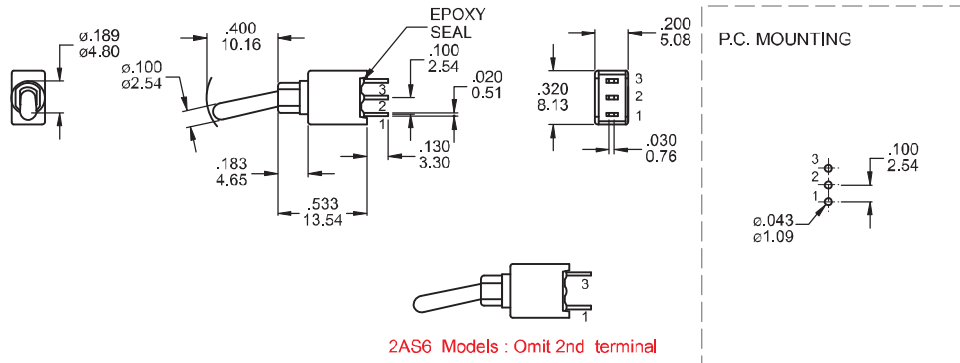

2AS6 Models : Omit 2nd terminal

SPDT

Part No. Shown : 2AS1T1A1M2RES

M2

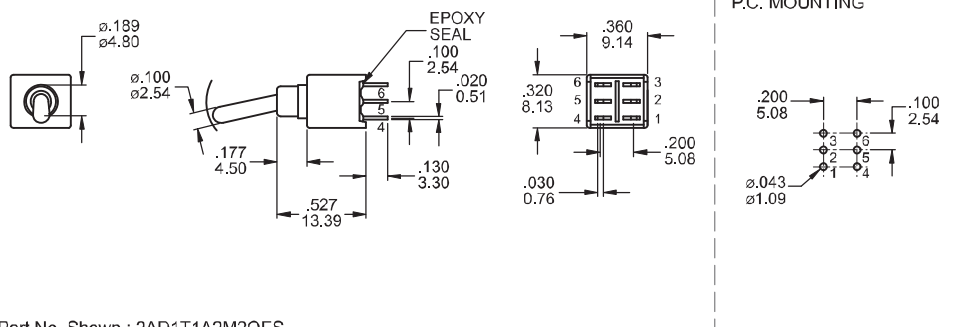

DPDT

Part No. Shown : 2AD1T1A2M2QES

2A Series

Sealed Sub-Miniature Toggle Switches



2A
Toggle Switches

ACTUATOR OPTIONS

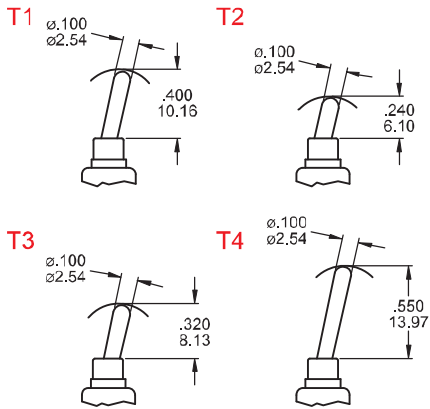

Actuator shown with A1 Bushing,
sub .020 (0.50) for A3 Bushing.

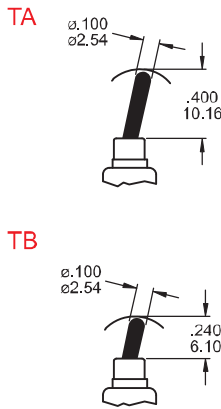

PLASTIC ACTUATOR

BUSHING OPTIONS

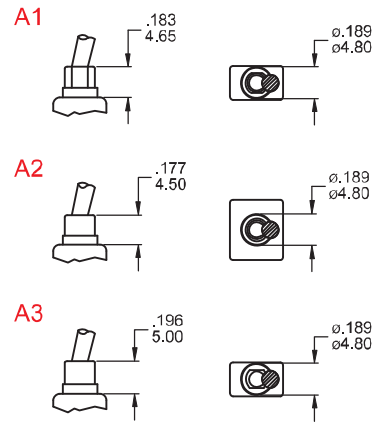

A1, A3 FOR SPDT / A2 FOR DPDT

TERMINATION OPTIONS

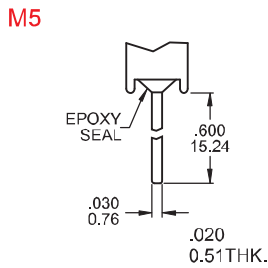
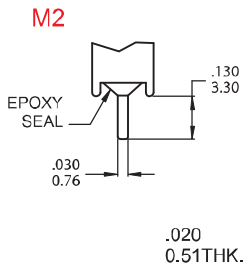

OTHER TERMINATION OPTIONS

- M6** Right angle P.C. Mount
- M6N** Right angle P.C. Mount
Snap-in bracket
- M7** Vertical right angle P.C. Mount
- M7N** Vertical right angle P.C. Mount
Snap-in bracket
- VS2** Vertical bracket P.C. Mount

M6

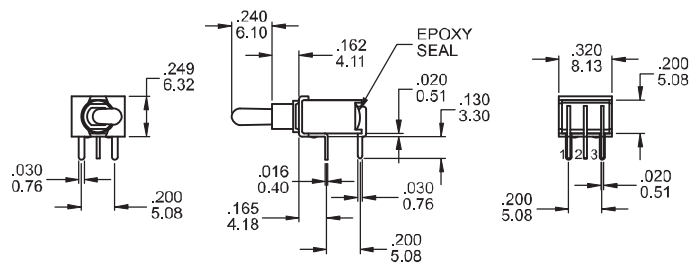

P.C. MOUNTING

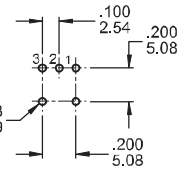

SPDT

Part No. Shown : 2AS1T2A1M6QES

M6

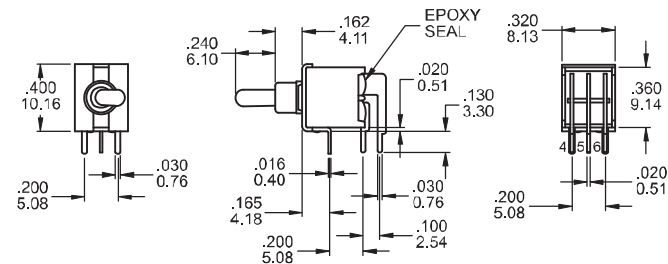
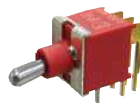

P.C. MOUNTING

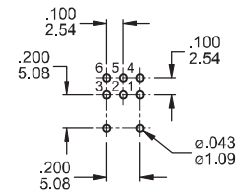

DPDT

Part No. Shown : 2AD1T2A2M6RES

2A Series

Sealed Sub-Miniature Toggle Switches



2A
Toggle Switches

M7

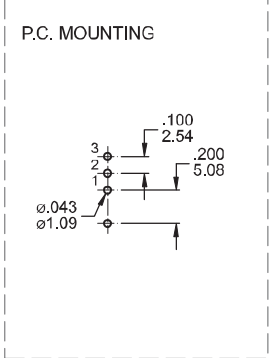
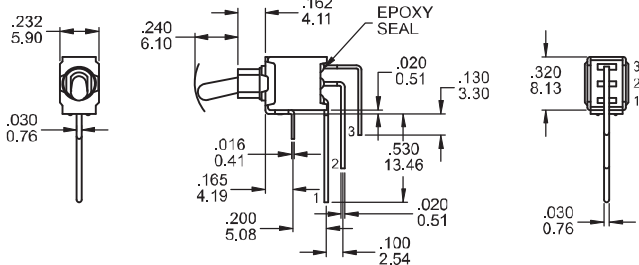

SPDT

Part No. Shown : 2AS1T2A1M7RES

M7

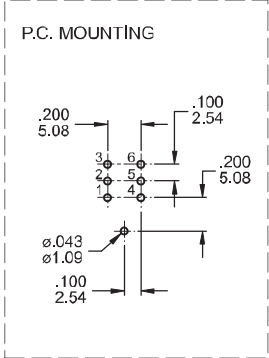
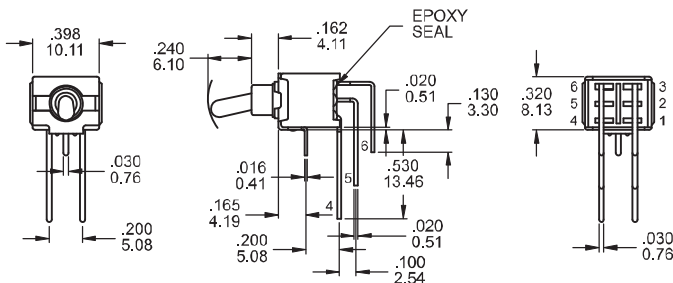
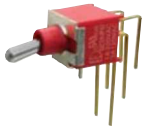

DPDT

Part No. Shown : 2AD1T2A2M7QES

VS2

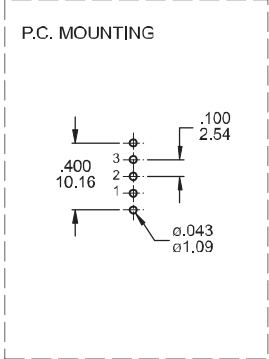
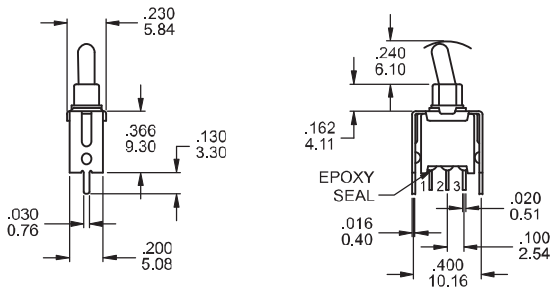

SPDT

Part No. Shown : 2AS1T2A1VS2RES

VS2

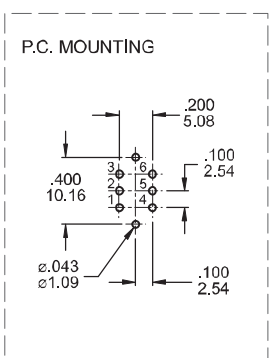
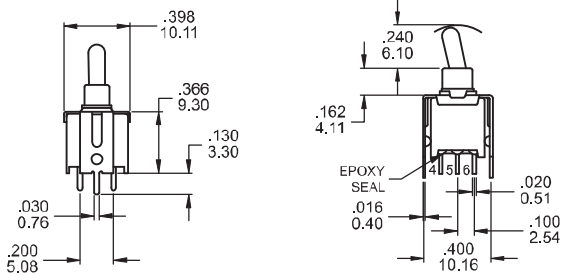

DPDT

Part No. Shown : 2AD1T2A2VS2QES

2A Series

Sealed Sub-Miniature Toggle Switches

SNAP-IN TERMINATION OPTIONS



2A
Toggle Switches

M6N

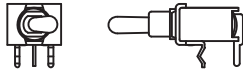

M7N

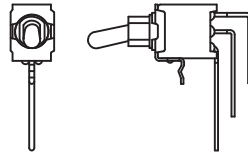

V2N

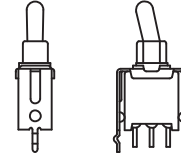

CONTACT MATERIAL OPTIONS

	CONTACT PLATING	TERMINAL PLATING	RATINGS
Q	Silver	Q = Gold flash over silver	3 Amps with resistant load @ 120VAC or 28VDC
C	Gold over Silver	C = Gold over silver	1 Amps with resistant load @ 250VAC
R	Gold	R = Gold	0.4 Volt - Amps (VA) max. @ 20V max. (AC or DC)

SOLDERING PROCESSES

MANUAL SOLDERING: Use soldering iron of 30 watts, controlled at 350°C approximately 5 seconds while applying solder.

WAVE SOLDERING: Recommended Soldering Temperature: 270 ± 5°C

Duration of Solder Immersion: Max 5 sec. (PCB is 1.6mm in thickness)