

# 8M Series

Sub-Miniature Pushbutton Switches

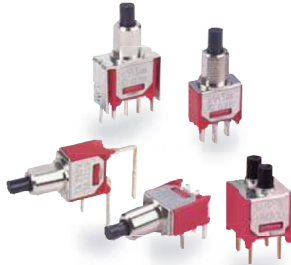

## SPECIFICATIONS

**CONTACT RATING:** Dependent upon contact material See Page 120.

**MECHANICAL LIFE:** 50,000 make-and-break cycles.

**CONTACT RESISTANCE:** 20 mΩ max. initial @ 2-4VDC  
100mA for both silver and gold plated contacts.

**INSULATION RESISTANCE:** 1,000 MΩ min.

**DIELECTRIC STRENGTH:** 1,000 Vrms min. @ sea level.

**OPERATING TEMPERATURE:** -30°C to 85°C.

## MATERIALS

**CASE:** Diallyl phthalate(DAP) (UL94V-0).

**PLUNGER:** Nylon 6/6,black.

**BUSHING:** Brass or zinc,nickel plated.

**HOUSING:** Stainless Steel.

**SWITCH SUPPORT:** Brass,tin plated.

**CONTACT/TERMINAL:** Copper alloy or Brass, with silver or gold plated.(See Page 120)



8M Pushbutton Switches

## HOW TO ORDER

MODEL NO.	ACTUATOR	BUSHING	TERMINATIONS	TERMINAL PLATING	SEAL	RoHS SOLDERING	ADDITIONAL HARDWARE	CAPS	CAP COLOR
Model NO. 8MS8 On-Mom. 8MS9 Off-Mom.	Actuator P1 3.94 high	Bushing B05 5.59 high flat (thd) B06 5.59 high flat (non-thd) B07 5.59 high (non-thd) B08 7.87 high (non-thd) B09 7.87 high (thd) B10 3.30 high	Terminations M1 Solder Lug M2 PC thru-hole M5 Wire wrap M6 Right angle, PC thru-hole M6N Right angle, snap-in, PC thru-hole M7 Vertical right angle, PC thru-hole M7N Vertical rightangle, snap-in, PC thru-hole VS2 8.94 high, V-bracket V2N 8.94 high, snap-in V-bracket	Terminal plating Q Silver R Gold C Gold over silver	Seal E EPOXY (std) N NO EPOXY	RoHS soldering S RoHS & Lead Free	Additional hardware 0 Without 5 Additional hardware	Caps (See Page 117) C1 C3 C4	CAP COLOR
* Single option 8MD9 Off-Mom	P1B10 4.10 high (std)								

ITEM NO	COLOR
1	White
2	Black (Std)
3	Red
4	Orange
5	Yellow
6	Green
7	Blue
8	Brown
9	Gray

\* Besides standard color, other colors need to check stocks available.

MODEL NO.	FRAME	FRAME COLOR	CAP COLOR	TERMINATIONS	TERMINAL PLATING	SEAL	RoHS SOLDERING
Model NO. 8MS8 On-Mom. 8MS9 Off-Mom.	Frame AP1 Snap-in with frame	Color		Terminations M1 Solder Lug M2 PC thru-hole M5 Wire wrap M6 Right angle, PC thru-hole M7 Vertical right angle, PC thru-hole VS2 8.94 high, V-bracket V2N 8.94 high, snap-in V-bracket	Terminal plating Q Silver R Gold C Gold over silver	Seal E EPOXY (std) N NO EPOXY	RoHS soldering S RoHS & Lead Free

ITEM NO	COLOR
1	White
2	black (Std)
3	Red
4	Orange
5	Yellow
6	Green
7	Blue
8	Brown
9	Gray

\* Besides standard color, other colors need to check stocks available.

# 8M Series

Sub-Miniature Pushbutton Switches

## SWITCH FUNCTION

NO. POLES	UL/CSA MODEL NO.	MODEL NO.	SWITCH FUNCTION		CONNECTED TERMINALS / SCHEMATIC	
			POS.1	POS.2	POS.1	POS.2
SP	Q2818	8MS8	ON	MOM	2-1 NC 1 • 2 (COMM) • 3 NO	2-3 NC 1 • 2 (COMM) • 3 NO
	Q2819	8MS9	OFF	MOM	OPEN	1-3 1 1 3
DP	Q2829	8MD9	OFF	MOM	OPEN	1-3,4-6 1 1 3 4 1 6

MOM=MENTORY



## POLE OPTIONS

8M  
Pushbutton Switches

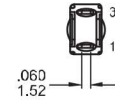
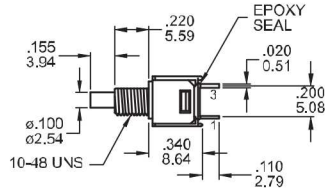
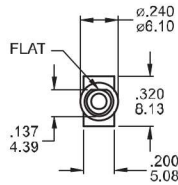

SPST

Part No. Shown : 8MS9P1B05M1QE

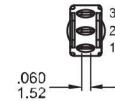
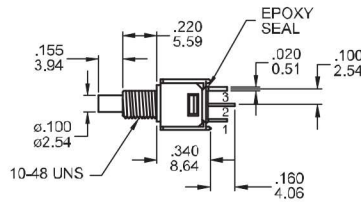
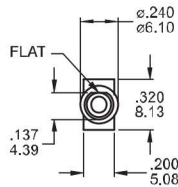

SPDT

Part No. Shown : 8MS8P1B05M1QE

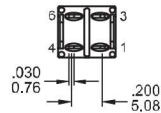
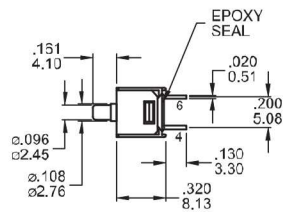
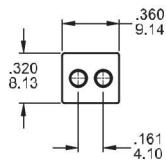

DPST

Part No. Shown : 8MD9P1B10M2RE

# 8M Series

Sub-Miniature Pushbutton Switches

## BUSHING OPTIONS

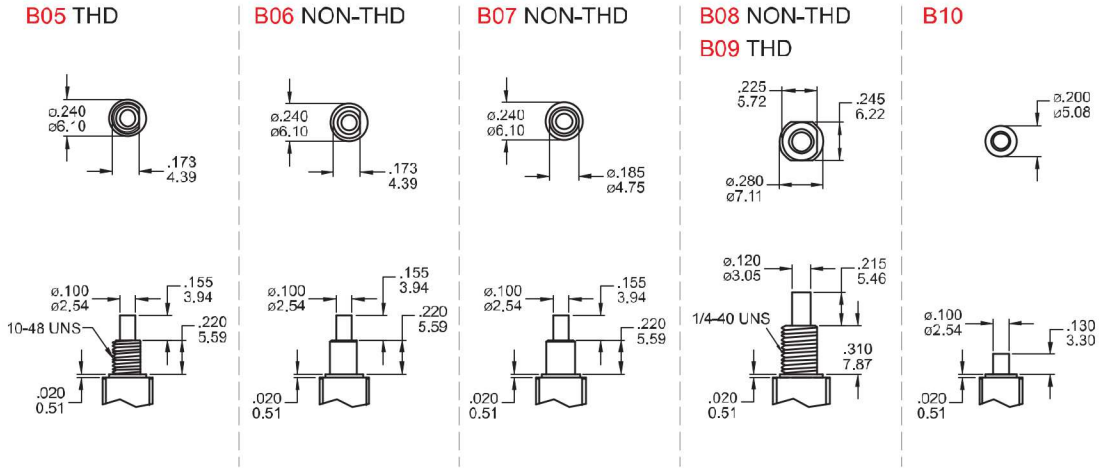

## TERMINATION OPTIONS

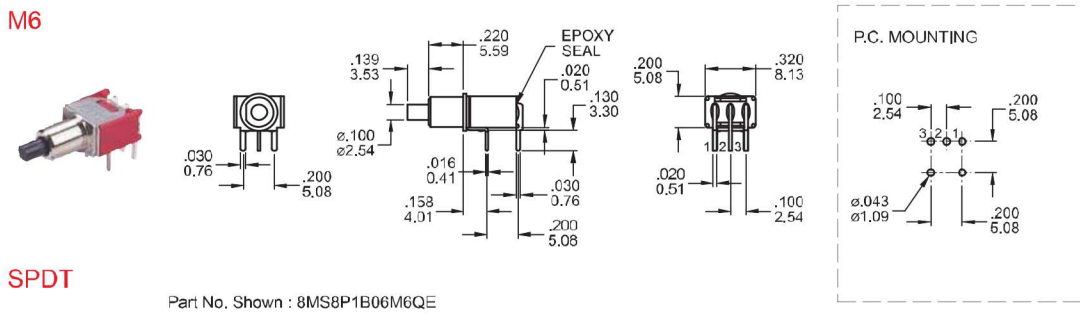
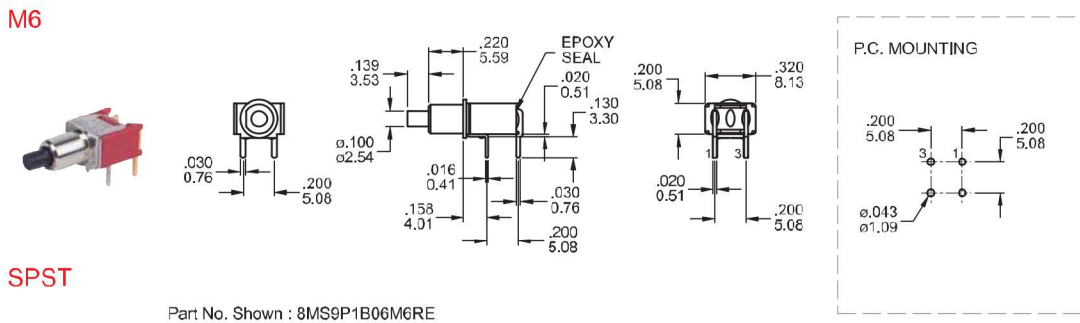
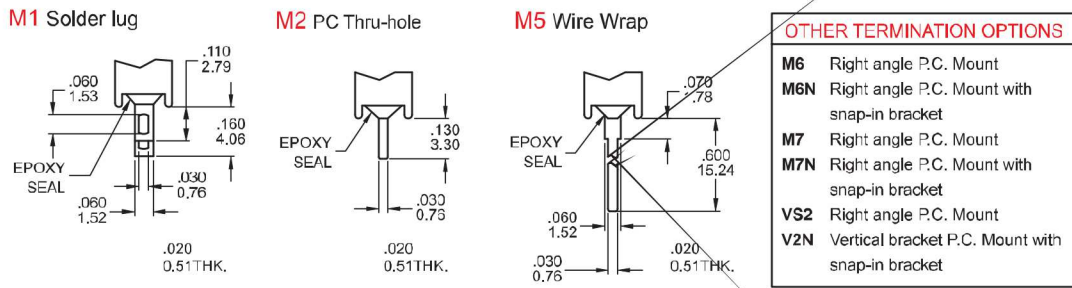

8M Pushbutton Switches

# 8M Series

Sub-Miniature Pushbutton Switches

## M6

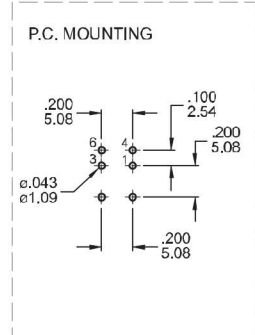
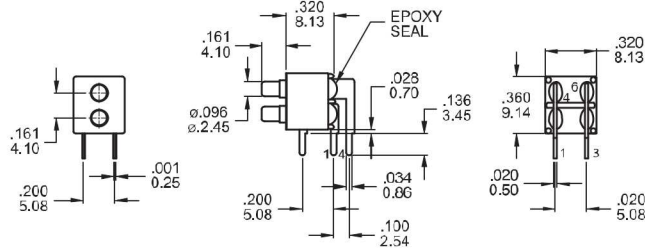

## DPST

Part No. Shown : 8MD9P1B10M6RE

8M Pushbutton Switches

## M7

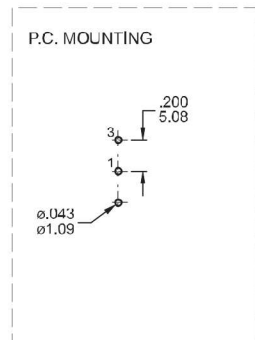
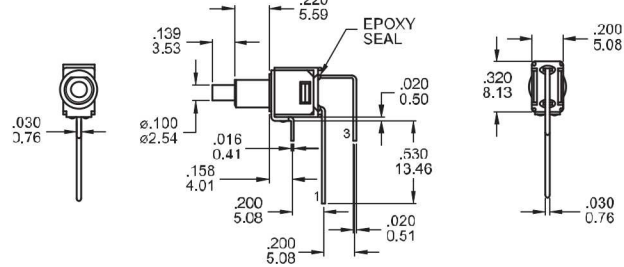

## SPST

Part No. Shown : 8MS9P1B06M7QE

## M7

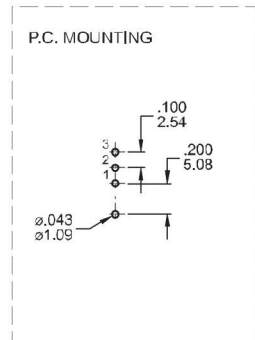
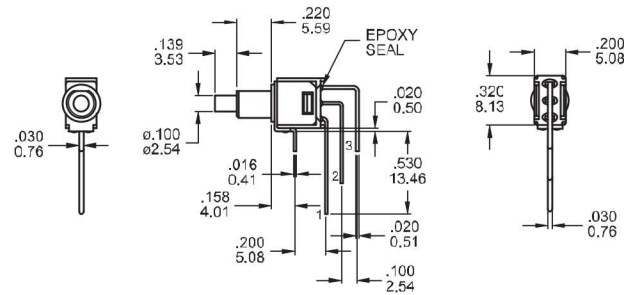

## SPDT

Part No. Shown : 8MS8P1B06M7QE

## VS2

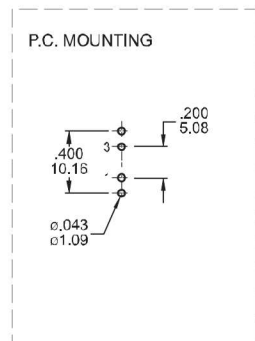
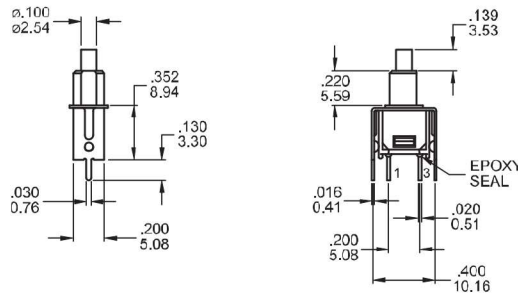

## SPST

Part No. Shown : 8MS9P1B06VS2QE

# 8M Series

Sub-Miniature Pushbutton Switches

VS2

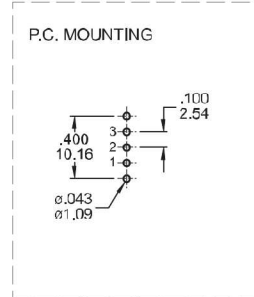
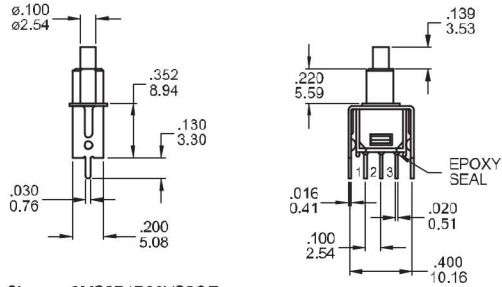

SPDT

Part No. Shown : 8MS8P1B06VS2QE

AP1

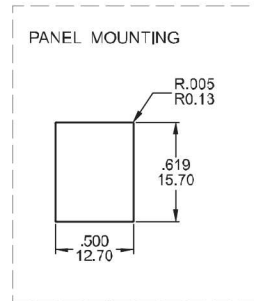
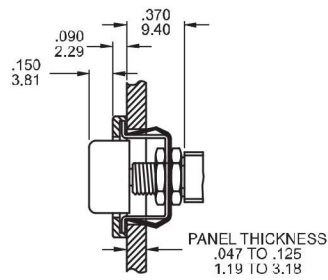
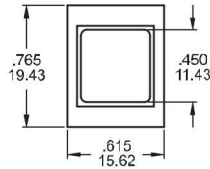

SPST

Part No. Shown : 8MS9AP122M1QE

## SNAP-IN TERMINATION OPTIONS

M6N

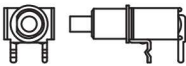

M7N

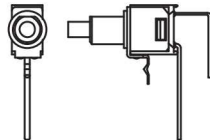

V2N

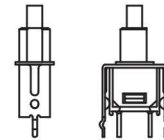

## CAP OPTIONS

C1 For 8M Series ONLY

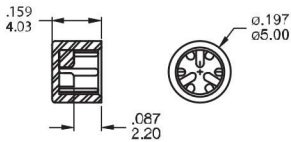

C2 For 8A,8B Series ONLY

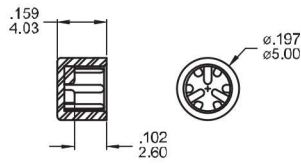

C3 For 8M Series B8,B9 Bushing ONLY

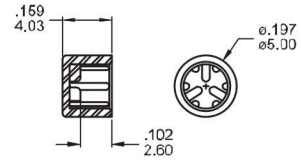

C4 For 8M Series ONLY

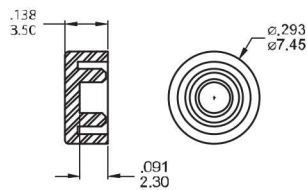

C5 For 8A,8B Series ONLY

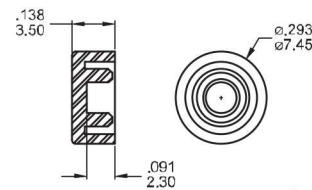

Cap Standard Color : White, Black, Red, Green

8M Pushbutton Switches